

KD171

Desktop

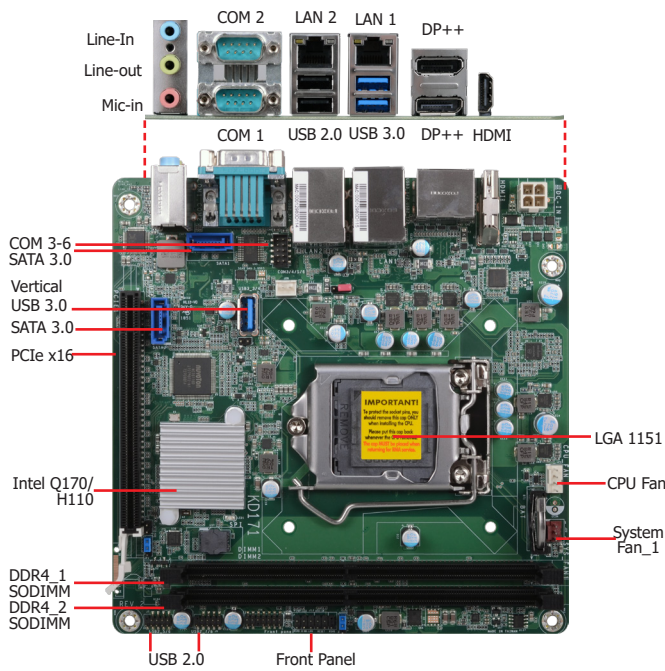

Features

- 2 DDR4 UDIMM up to 32GB
- Three independent displays: DP++ + DP++ + HDMI (Q170)
- DP++ resolution up to 4096x2160 @ 60Hz
HDMI 1.4 resolution up to 4096x2160 @ 24Hz
- Expansion: 1 PCIe x16
- Storage: 2 SATA 3.0
- Rich I/O: 2 GbE, 6 COM, 3 USB 3.0, 6 USB 2.0

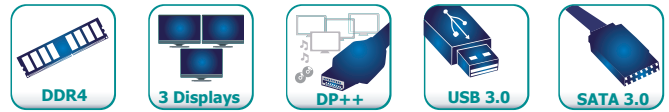

Ordering Information

Model Name	P/N	Memory	GbE	DP	HDMI	RS-232	SATA 3.0	USB 3.0	USB 2.0	Power	Thermal	Temp.
KD171-H110	770-KD1711-000G	2 UDIMM	2	2	1	6	2	3	6	12V DC	Active	0 to 60°C
KD171-Q170	770-KD1711-100G	2 UDIMM	2	2	1	6	2	3	6	12V DC	Active	0 to 60°C
KD171-H110	770-KD1711-200G	2 UDIMM	2	2	1	6	2	3	6	12V 4-pin vertical	Active	0 to 60°C
KD171-Q170	770-KD1711-300G	2 UDIMM	2	2	1	6	2	3	6	12V 4-pin vertical	Active	0 to 60°C

Mechanical Drawing

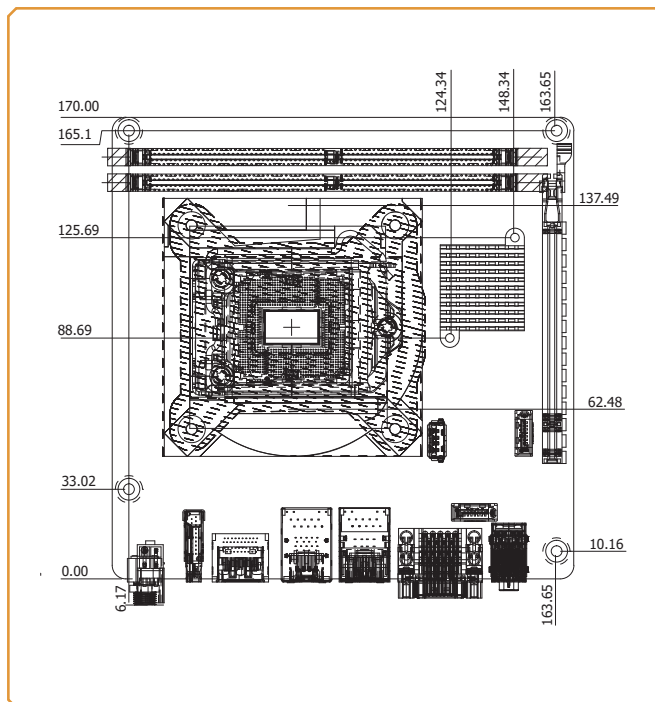

Block Diagram

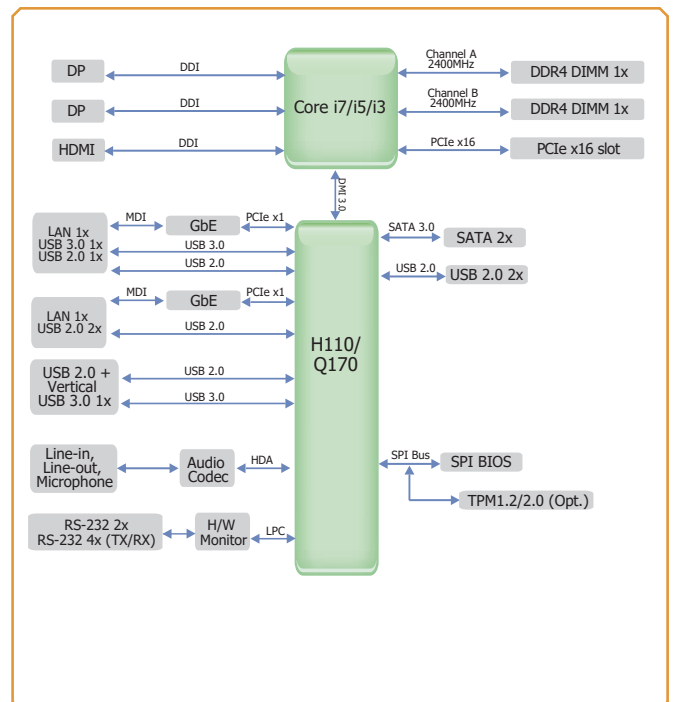

Specifications

SYSTEM	Processor	6th/7th Generation Intel® Core™ Processors, LGA 1151 Socket Intel® Core™ i7-7700T Processor, Quad Core, 8M Cache, 2.9GHz (3.8GHz), 35W Intel® Core™ i7-7700 Processor, Quad Core, 8M Cache, 3.6GHz (4.2GHz), 65W Intel® Core™ i5-7500T Processor, Quad Core, 6M Cache, 2.7GHz (3.3GHz), 35W Intel® Core™ i5-7500 Processor, Quad Core, 6M Cache, 3.4GHz (3.8GHz), 65W Intel® Core™ i3-7101E Processor, Dual Core, 3M Cache, 3.9GHz, 54W Intel® Core™ i3-7101TE Processor, Dual Core, 3M Cache, 3.4GHz, 35W Intel® Celeron® G3930, Dual Core, 3M Cache, 2.9GHz, 51W Intel® Celeron® G3930E, Dual Core, 3M Cache, 2.9GHz, 54W Intel® Core™ i7-6700TE, Quad Core, 2.4GHz (3.4GHz), 35W Intel® Core™ i5-6500TE, Quad Core, 2.3GHz (3.3GHz), 35W Intel® Core™ i7-6700, Quad Core, 8M Cache, 3.4GHz (4.0GHz), 65W Intel® Core™ i5-6500, Quad Core, 6M Cache, 3.2GHz (3.6GHz), 65W Intel® Core™ i3-6100, Dual Core, 3.7GHz, 51W Intel® Core™ i3-6100TE, Dual Core, 2.7GHz, 35W Intel® Pentium® G4400, Dual Core, 3.3GHz, 54W Intel® Pentium® G4400TE, Dual Core, 2.4GHz, 35W Intel® Celeron® G3900, Dual Core, 2.8GHz, 51W Intel® Celeron® G3900TE, Dual Core, 2.3GHz, 35W	
	Chipset	Intel® Q170/H110	
	Memory	Two 288-pin UDIMM up to 32GB	Dual Channel DDR4 2133/2400 MHz
	BIOS	Insyde SPI	
	GRAPHICS	Controller	Intel® HD Gen 9 Graphics
	Feature	OpenGL 5.0, DirectX 12, OpenCL 2.1 HW Decode: AVC/H.264, MPEG2, VC1/WMV9, JPEG/MJPEG, HEVC/H265, VP8, VP9 HW Encode: MPEG2, AVC/H264, JPEG, HEVC/H265, VP8, VP9	
	Display	2 x Full Size DP++ 1 x HDMI 1.4 (optional)	Full Size DP++: resolution up to 4096x2160 @ 60Hz HDMI: resolution up to 4096x2160 @ 24Hz
	Triple Displays	Q170: DP++ + DP++ + HDMI H110: DP++ + DP ++, DP++ + HDMI	
EXPANSION	Interface	1 x PCIe x16 (Gen 3)	
ETHERNET	Controller	2 x GbE (10/100/1000Mbps) 2 x Realtek® 8111HN or 8119 (opt.)	
REAR I/O	Ethernet	2 x GbE (RJ-45)	
	Serial	2 x RS-232 (DB-9)	
	USB	2 x USB 3.0 2 x USB 2.0	
	Display	2 x Full Size DP++ 1 x HDMI 1.4 (optional)	
	Audio	1 x Line-in 1 x Line-out 1 x Mic-in	
INTERNAL I/O	Serial	4 x RS-232 (TX/RX only)	
	USB	1 x Vertical USB 3.0 4 x USB 2.0	
	SATA	2 x SATA 3.0 (up to 6Gb/s)	
WATCHDOG TIMER	Output & Interval	System Reset, Programmable via Software from 1 to 255 Seconds	
SECURITY	TPM	Infineon TPM 2.0	
POWER	Type	12V DC	
	Connector	DC Jack	Vertical Type Connector (4-pin) (opt.)
	Consumption	Idle: i7-7700 65W: 12V @ 0.85A (10.2W) Max: i7-7700 65W: 12V @ 9.16A (109.92W)	
	RTC Battery	CR2032 Coin Cell	
OS SUPPORT	Microsoft/Linux	Windows 10 LTSB (64 bits) Window 7 (32/64bit) for 6th Generation Processors Linux	
ENVIRONMENT	Temperature	Operating: 0 to 60°C	Storage: -40 to 85°C
	Humidity	Operating: 5 to 90% RH	Storage: 5 to 90% RH
	MTBF	KD171-Q170: 1,454,376 hrs @ 25°C; 737,553 hrs @ 45°C ; 447,012 hrs @ 60°C KD171-H110: 1,454,376 hrs @ 25°C; 737,553 hrs @ 45°C ; 447,012 hrs @ 60°C Calculation model: Telcordia Issue 4 Environment: GB, GC – Ground Benign, Controlled	
MECHANICAL	Dimensions	Mini-ITX Form Factor	170mm (6.7") x 170mm (6.7")
	Height	PCB: 1.6mm	
CERTIFICATIONS	CE, FCC Class A, RoHS		

Packing List

• 1 KD171-Q170/H110 motherboard	
• 1 Serial ATA data cable (Length: 500mm)	332-553001-005G
• 1 Serial ATA power cable (Length: 260mm)	A81-000008-018G
• COM port cable (Length: 300m)	A81-015041-018G

Optional Items

• USB 2.0 port cable (Length: 200mm)	A81-001032-016G
• Serial ATA power cable (Length: 260mm)	A81-000008-018G
• Serial ATA data cable (Length: 500mm)	332-553001-005G
• Thermal solution (For 35W, Height: 37.3mm)	A71-103004-000G
• Thermal solution (For 65W, Height: 72.8mm)	552-200049-000G
• I/O shield	A49-KD1710-010G