

EMPL-G2P1 mPCIe to dual Isolated PoE Module

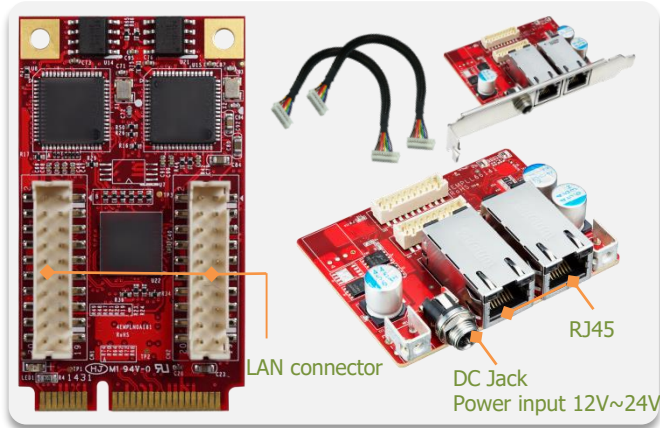

Features

- Supports dual isolated GbE LAN ports
- Two independent PSE channels
- Supports 12V~24V power input via DC-Jack
- Complies with IEEE 802.3af, up to 15.4W at 48V per PoE port.
- Complies with IEC 60950-1:2005 + A1: 2009 + A2:2013 1.7KV HiPOT protection
- Complies with EN61000-4-2 (ESD) Air-15kV, Contact-8kV
- Industrial temperature -40 °C to 85 °C

Mechanical Drawing

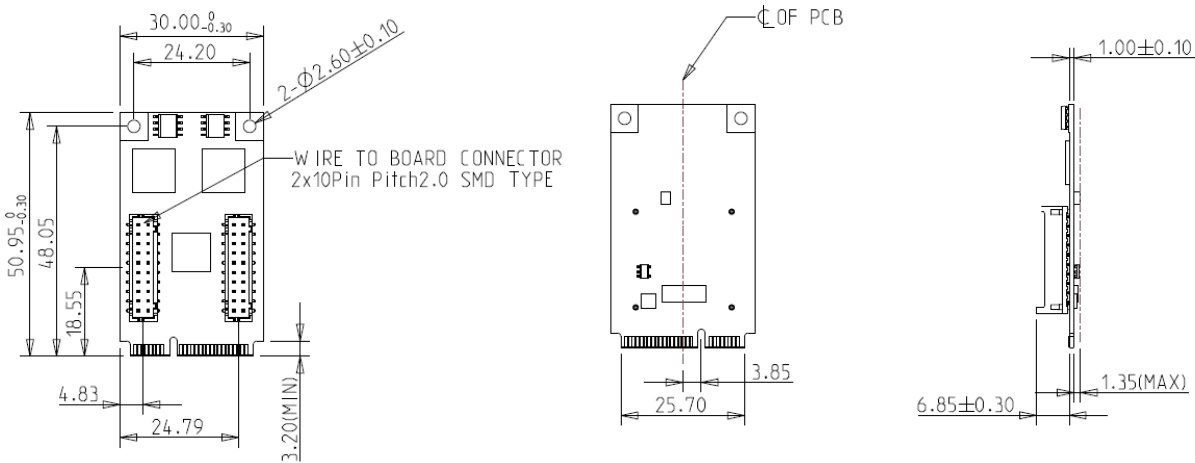

Specifications

Form-Factor	mPCIe
Input I/F	PCI Express 2.1 x 1
Output I/F	PoE x 2
Output Connector	RJ45 x 2
TDP	30W
Dimension (WxLxH)	Main Board: 30 x 50.9 x 9.2 mm Daughter Board: 72.7 x 58.2 x 23.8 mm
Temperature	Operation: STD: 0°C ~ +70°C. W/T: -40°C ~ +85°C Storage: -55°C ~ +95°C
Environment	Vibration: 5G @7~2000Hz, Shock: 50G @ 0.5ms
Notes	Please download driver from MyInnodisk website. Windows: XP(32bit), 7(32/64bit), 8/8.1(32/64 bit), 10(32/64bit) Linux: kernel 2.4 series, 2.6.x and 3.x version.
Limitations	EMPL-G2P1 series does not recommend used in VMware ESXi due to High Latency

Headquarters (Taiwan)

5F., No.237, Sec. 1, Datong Rd.,
Xizhi Dist., New Taipei City 221,
Taiwan

Tel: +886-2-7703-3000
Email: sales@innodisk.com

Branch Offices:

USA

usasales@innodisk.com
+1-510-770-9421

Europe

eusales@innodisk.com
+31-40-3045-400

Japan

jpsales@innodisk.com
+81-3-6667-0161

China

sales_cn@innodisk.com
+86-755-2167-3689

www.innodisk.com

© 2020 Innodisk Corporation.
All right reserved. Specifications
are subject to change without
prior notice.

October 6, 2020

Order information

EMPL-G2P1-C3 (Mounting hole, DC Jack, Standard Temp.)

EMPL-G2P1-W3 (Mounting hole, DC Jack, Wide Temp.)

EMPL-G2P1-C4 (Bracket, DC Jack, Standard Temp.)

EMPL-G2P1-W4 (Bracket, DC Jack, Wide Temp.)

mPCIe to Dual Isolated PoE Module

EMPL-G2P1-C3/W3 Daughter Board and Mechanical Drawing

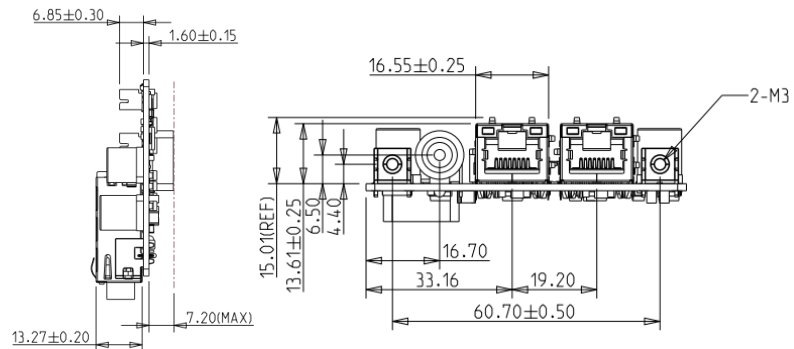
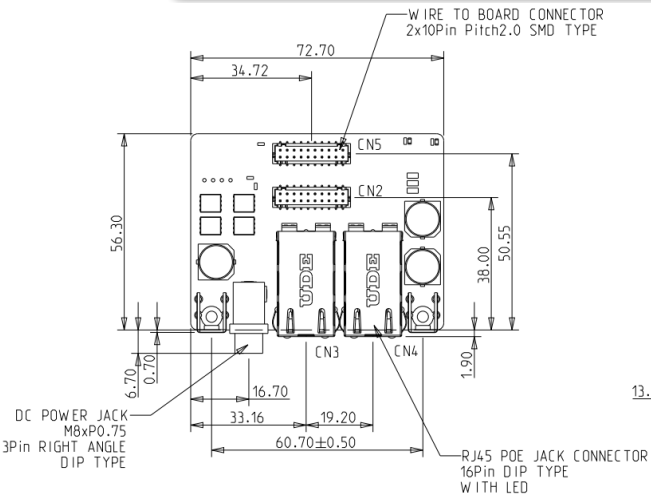
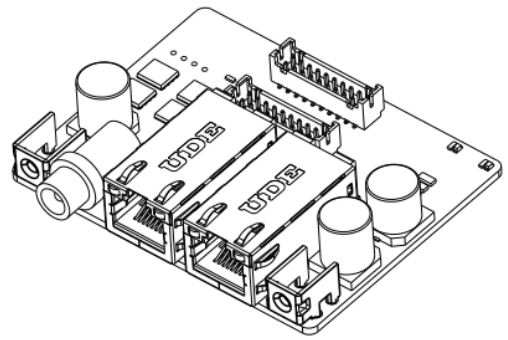
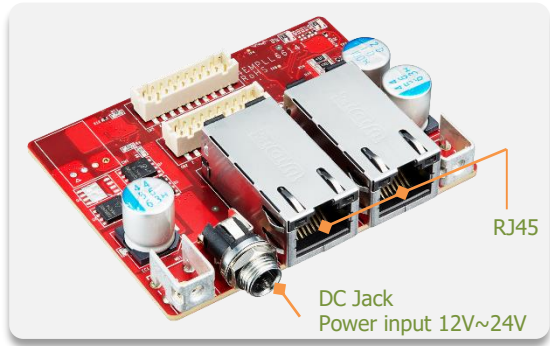

EMPL-G2P1-C4/W4 Daughter Board and Mechanical Drawing

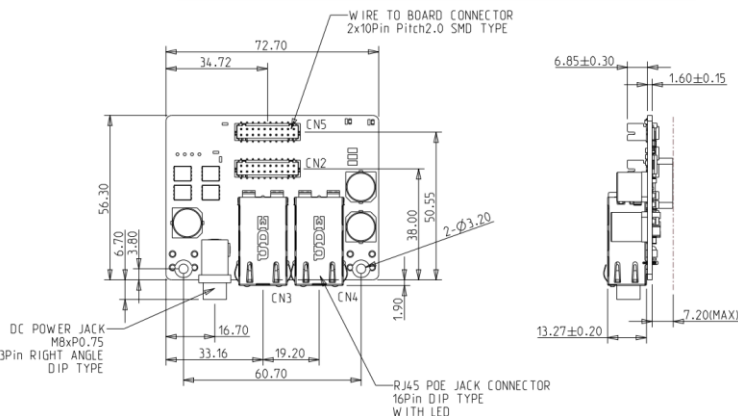
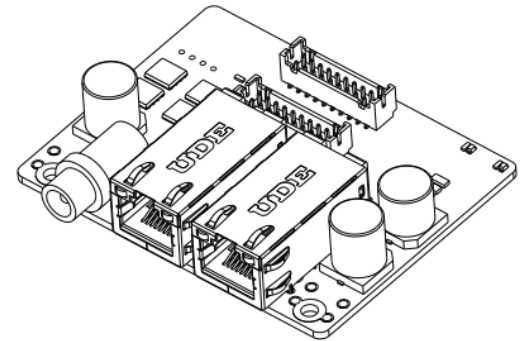
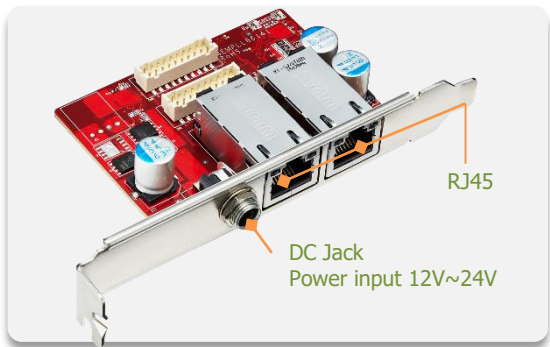

Bracket

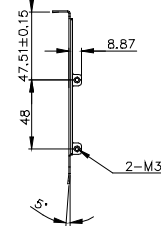
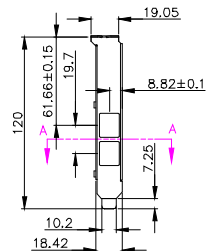
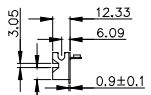
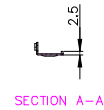
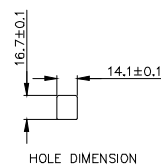

TOLERANCE: ±0.20mm

EMPL-G2P1

mPCIe to dual Isolated PoE Module

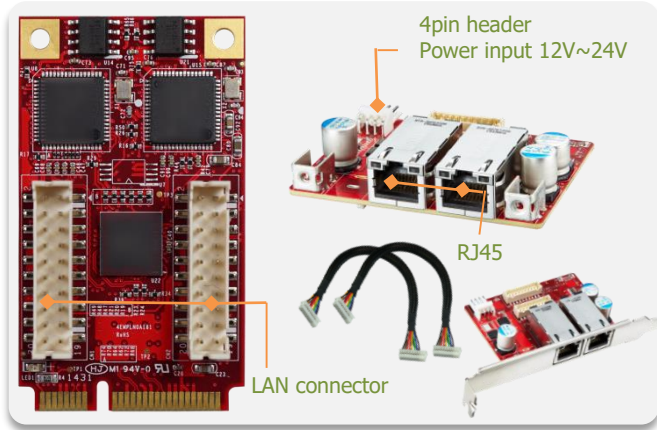

Features

- Supports dual isolated GbE LAN ports
- Two independent PSE channels
- Supports 12V~24V power input via 4pin header
- Complies with IEEE 802.3af, up to 15.4W at 48V per PoE port.
- Complies with IEC 60950-1:2005 + A1: 2009 + A2:2013 1.7KV HiPOT protection
- Complies with EN61000-4-2 (ESD) Air-15kV, Contact-8kV
- Industrial temperature -40 °C to 85 °C

Mechanical Drawing

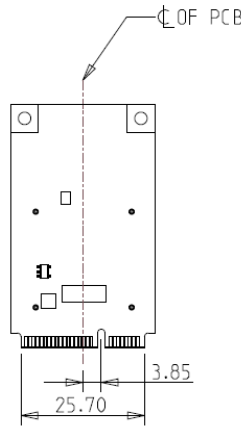
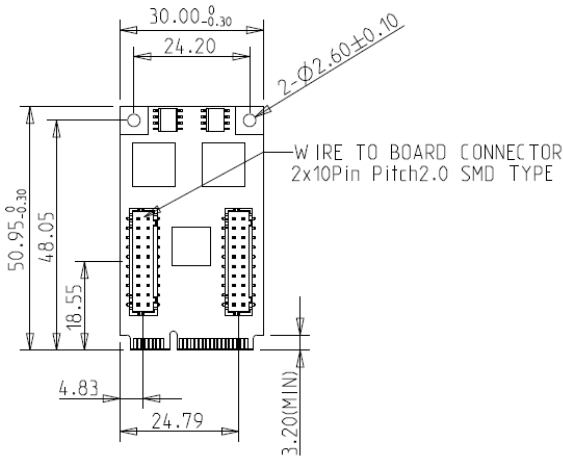

4pin header power input pin define			
1	2	3	4
NC	GND	GND	12V-24V

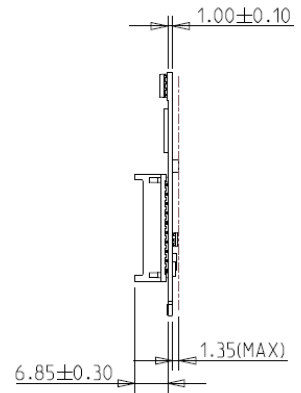

Specifications

Form-Factor	mPCIe
Input I/F	PCI Express 2.1 x 1
Output I/F	PoE x 2
Output Connector	RJ45 x 2
TDP	30W
Dimension (WxLxH)	Main Board: 30 x 50.9 x 9.2 mm Daughter Board: 72.7 x 58.2 x 23.8 mm
Temperature	Operation: STD: 0°C ~ +70°C. W/T: -40°C ~ +85°C Storage: -55°C ~ +95°C
Environment	Vibration: 5G @7~2000Hz, Shock: 50G @ 0.5ms
Notes	Please download driver from MyInnodisk website. Windows: XP(32bit), 7(32/64bit), 8/8.1(32/64 bit), 10(32/64bit) Linux: kernel 2.4 series, 2.6.x and 3.x version.
Limitations	EMPL-G2P1 series does not recommend used in VMware ESXi due to High Latency

Headquarters (Taiwan)

5F., No.237, Sec. 1, Datong Rd.,
Xizhi Dist., New Taipei City 221,
Taiwan

Tel: +886-2-7703-3000
Email: sales@innodisk.com

Branch Offices:

USA

usasales@innodisk.com
+1-510-770-9421

Europe

eusales@innodisk.com
+31-40-3045-400

Japan

jpsales@innodisk.com
+81-3-6667-0161

China

sales_cn@innodisk.com
+86-755-2167-3689

www.innodisk.com

© 2020 Innodisk Corporation.
All right reserved. Specifications
are subject to change without
prior notice.

October 6, 2020

Order information

EMPL-G2P1-C1 (Mounting hole, 4pin header, Standard Temp.)

EMPL-G2P1-W1 (Mounting hole, 4pin header, Wide Temp.)

EMPL-G2P1-C2 (Bracket, 4pin header, Standard Temp.)

EMPL-G2P1-W2 (Bracket, 4pin header, Wide Temp.)

mPCIe to dual Isolated PoE Module

EMPL-G2P1-C1/W1 Daughter Board and Mechanical Drawing

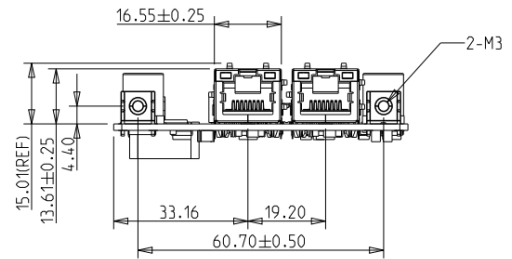
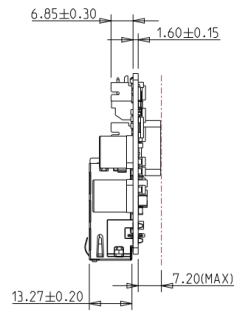
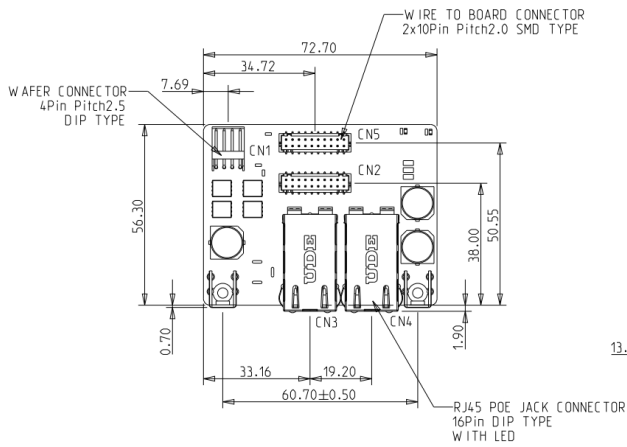
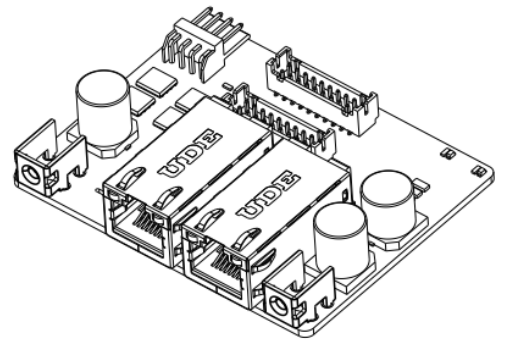
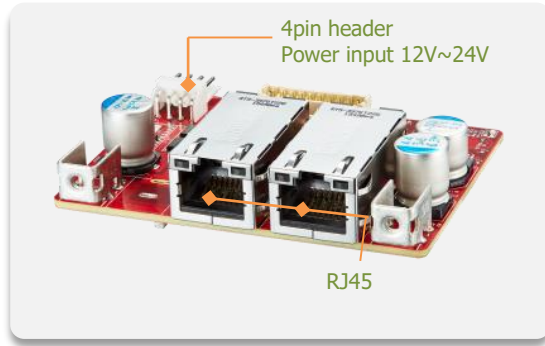

EMPL-G2P1-C2/W2 Daughter Board and Mechanical Drawing

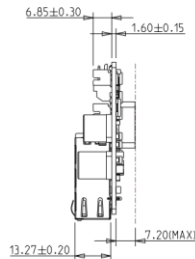
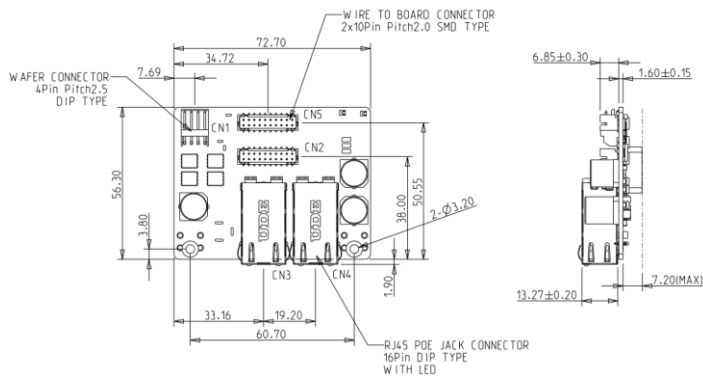
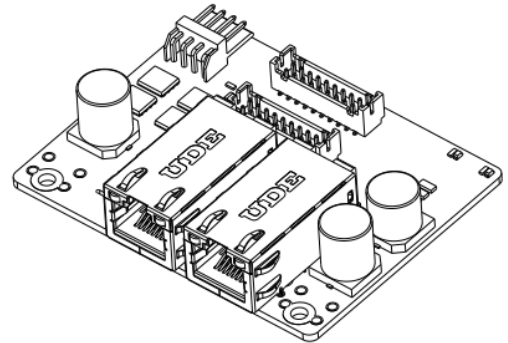
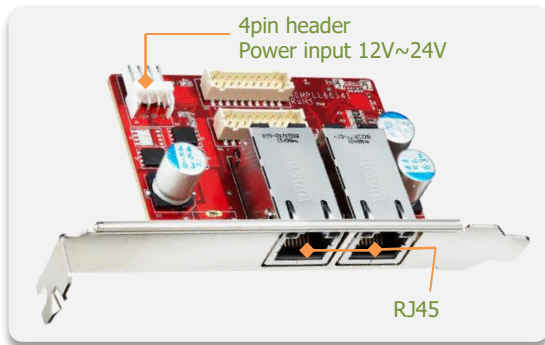

Bracket

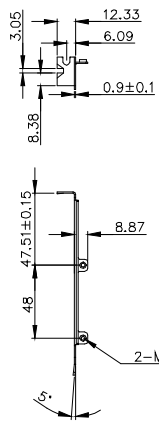
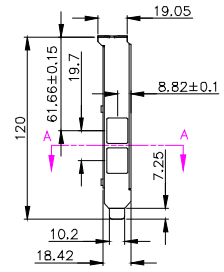
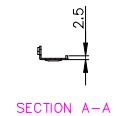
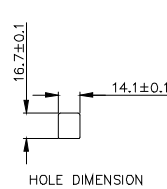

TOLERANCE: ±0.20mm