



# DT122-SD

Q170/  
H110



### ► Features

- 6th Gen Intel Core Desktop Box PC
- 1x 3.5"/ 2x 2.5" SATA drive bay  
1x optional slim ODD bay
- Supports 1 expansion slot: 1 PCIe x16 or 1 PCI

### ► Panel

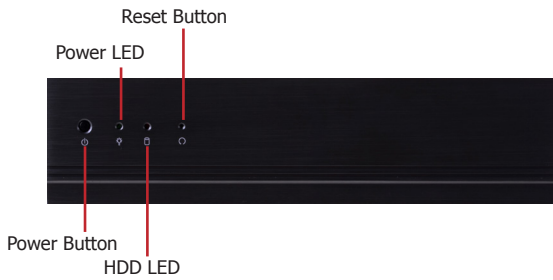

Front View

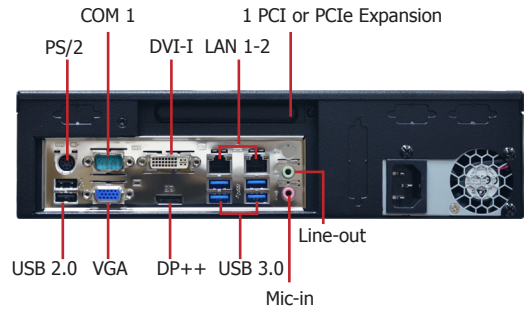

Rear View

### ► Dimensions

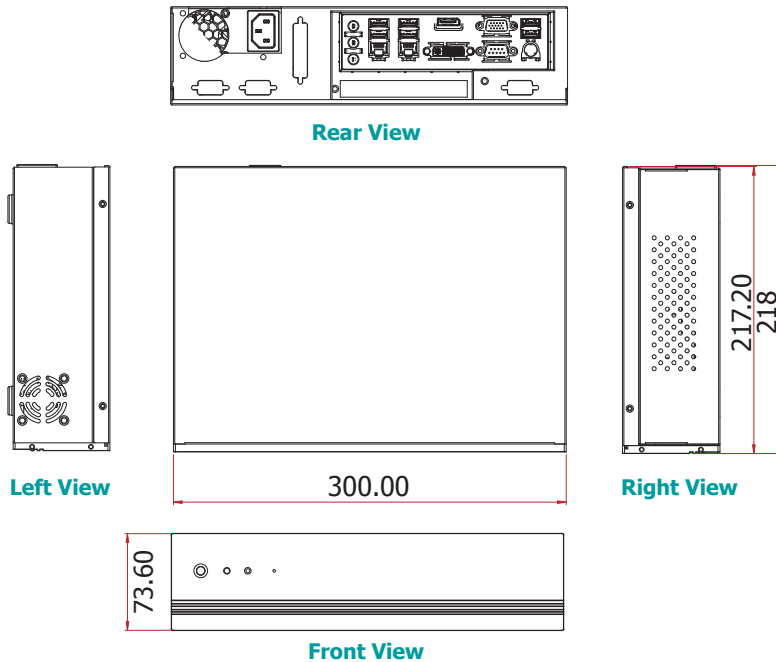



Wall Mounting

Type A Wall mount bracket

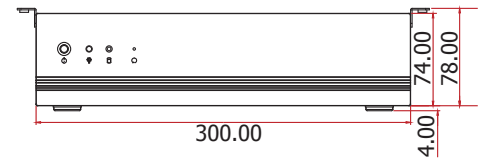
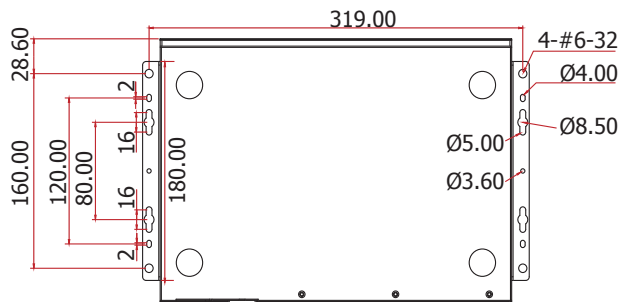
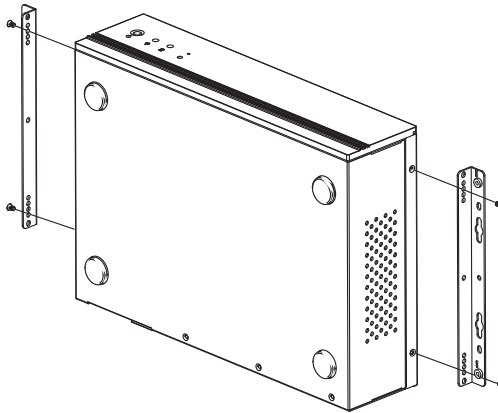

Type B Wall mount bracket

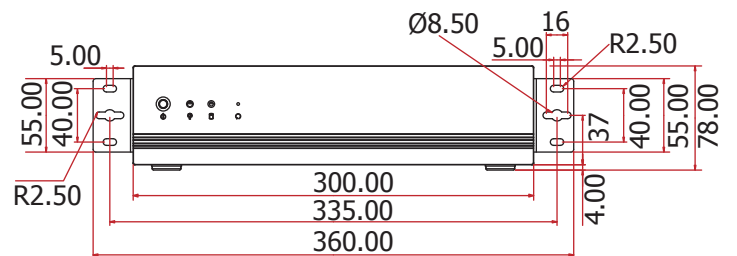
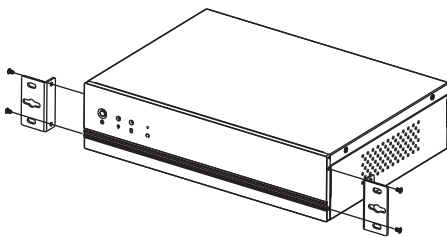

### ► Ordering Information

Model Name	Part Number	Description
<b>DT122-SD</b>	750-DT1221-000G	DT122-SD: SD100-Q170, 250W PSU, PCIe x16, SYSTEM F/G RoHS
<b>DT122-SD</b>	750-DT1221-100G	DT122-SD: SD100-H110, 250W PSU, PCIe x16, SYSTEM F/G RoHS
<b>DT122-SD</b>	750-DT1221-200G	DT122-SD: SD100-Q170, 250W PSU, PCI, SYSTEM F/G RoHS
<b>DT122-SD</b>	750-DT1221-300G	DT122-SD: SD100-H110, 250W PSU, PCI, SYSTEM F/G RoHS
<b>DT122-SD</b>	750-DT1221-400G	DT122-SD: SD100-Q170, 250W PSU, SYSTEM F/G RoHS
<b>DT122-SD</b>	750-DT1221-500G	DT122-SD: SD100-H110, 250W PSU, SYSTEM F/G RoHS

### ► Optional Items

Optional Items	Part Number	Description
<b>CPU</b>	785-1151DL	CPU, LGA1151, Long-Term Support, RoHS
<b>Memory</b>	785-RSOD416G	SODIMM, DDR4 Module, 16GB, RoHS
	785-RSOD48G	SODIMM, DDR4 Module, 8GB, RoHS
	785-RSOD44G	SODIMM, DDR4 Module, 4GB, RoHS
<b>HDD</b>	785-H351T0B	3.5" SATA HDD, 1TB, RoHS
	785-H35500G	3.5" SATA HDD, 500GB, RoHS
	785-H25500G	2.5" SATA HDD, 500GB, RoHS
<b>mSATA</b>	785-MS128GMF	mSATA Card, 128GB MLC, RoHS
	785-MS64GMF	mSATA Card, 64GB MLC, RoHS
	785-MS32GMF	mSATA Card, 32GB MLC, RoHS
	785-MS16GMF	mSATA Card, 16GB MLC, RoHS
	785-MS08GMF	mSATA Card, 8GB MLC, RoHS
	785-MS04GMF	mSATA Card, 4GB MLC, RoHS
<b>Wi-Fi</b>	761-110091-000G	Wi-Fi Kit, RoHS
<b>Power Cord</b>	785-PWRD	Power Cord, Standards (USA/EUR/CH), 1.8m, RoHS
<b>Wall Mount</b>	761-DT1220-100G	DT122 Type A Wall Mount Kit for Top Cover, RoHS
	761-DT1220-000G	DT122 Type B Wall Mount Kit for Front Cover, RoHS

### ► Packing List

• 1 DT122-SD system unit
• 1 CPU cooler
• 1 HDD drive bay kit
• 1 Heatsink/fan
• 1 Quick Installation Guide
• 1 CD disk includes:
- Drivers / Manual