

MEC-DIS-M002

Mini PCI-e DVI/VGA output graphic board



- Single-Lane (x1) PCI-Express with throughput up to 2.5Gbps
- Fully compliant with PCI-Express Base Specification Rev. 1.1
- Support simultaneously dual display output
- Industry- Leading 2D acceleration graphic engine
- On board video memory with 16MB DDR SDRAM
- Support 1280 x 1024 @ 60Hz DVI /VGA resolution



Overview

MEC-DIS-M002 is a graphic card for embedded PC. The card follows the Mini PCI-e standard which is compliant with PCI Express x 1 classification and small form factor (30.00 x 50.95 mm). This board fits in any host computer that has Mini PCI-e card slots.

Display Performance

MEC-DIS-M002 supports simultaneous dual display outputs, which are VGA and DVI outputs. The 2D acceleration graphic engine and embedded DDR memory efficiently reduce CPU loading and produce outstanding graphics performance.

High Usability

MEC-DIS-M002 is tested to be compatible with various Windows Operation Systems. The daughter board with bracket (1 DVI-I connector) and connection cable are included in the standard package.

MECFIX – Versatile Mounting

MECFIX is the unique mounting mechanism designed specially for MEC daughterboard. The feature of the mounting unit allows the following mounting options:

1. **Standard PCI/PCIe Bracket**
2. **Low Profile PCI/PCIe Bracket**
3. **Internal Mounting** inside of PC system from any position and angle.
4. **Customizing Front/Rear Plate** of PC system according to dimension of MEC daughterboard.

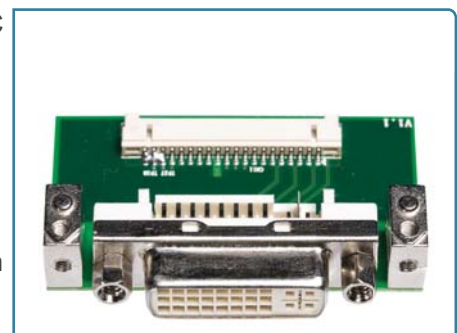

Specifications

General

PCI-Express Revision:

PCI-Express Base Specification Rev 1.1

PCI-Express Electromechanical Revision:

PCI-Express Mini Card Electromechanical Rev. 1.1

Hardware

Controllers: SiliconMotion SM750 with 16MB DDR SDRAM

Bus: Single-Lane (x1) PCI-Express with throughput up to 2.5Gbps

Interface (Connector)

DVI: 1 (DVI-I)

Performance

DVI Resolution: Up to 1280 x 1024, 60Hz

VGA Resolution: Up to 1280 x 1024, 60Hz

Driver Support

Operating Systems: Win 2003, Win XP,

Win Vista, Win 7, Win 8

Power Requirement

Power Consumption: 740mA@3.3V

Dimensions

Width x Length (mm): 30.00 x 50.95

Environmental Limits

Operating Temperature: -20°C ~ 70°C

Storage Temperature: -20°C ~ 85°C

Humidity: 5% ~ 95%

Regulatory Approvals

EMC: CE, FCC

EMI: EN 55022, EN61000-3-2, EN61000-3-3,

FCC Part 15 Subpart B

Class B

EMS: En 55024, IEC 61000-4-2, IEC 61000-4-3,

IEC 61000-4-4, IEC 61000-4-5, IEC 61000-4-6,

IEC 61000-4-8, IEC 61000-4-11

Reliability

MTBF: 1,425,435 hr

Warranty: 3 years

Dimensions

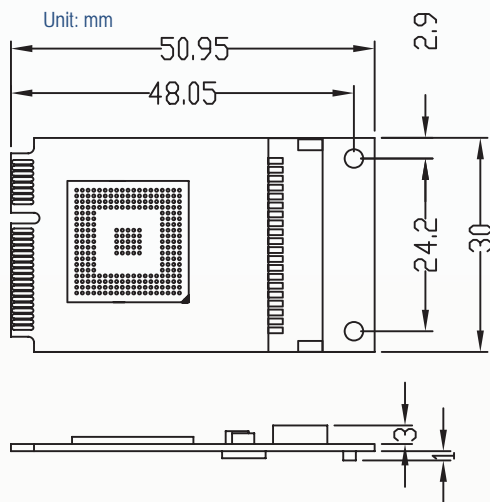

Daughter Board

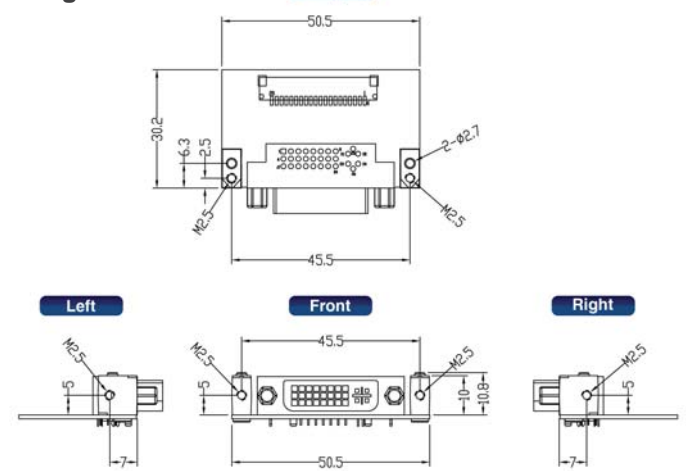

Package Checklist

- Mini PCI-e Card x 1
- Daughter Board (DVI-I connector) x 1
- Bracket x 1
- M2.5 Screw x 2
- 20Pin Internal Connection Cable (30cm) x 1
- Quick Installation Guide (Printed) x 1
- Driver CD x 1



Ordering Information

Available Models

MEC-DIS-M002

Mini PCI-e DVI/VGA output graphic board

MCB-DVIDVGA-20 DVI-I to 1x DVI-D and 1x VGA cable, 20cm (Optional)

