

The Most **Reliable**
Storage For Industries

ST170-300B mSATA mini

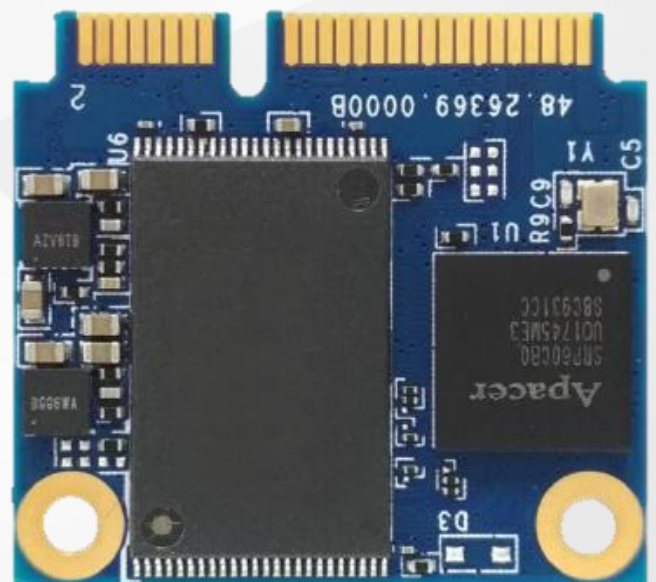

ST170-300B mSATA mini

Overview

Apacer's ST170-300B (JEDEC MO-300B) is a well-balanced solid-state disk (SSD) drive with standard form factor and great performance. Designed in SATA 6.0 Gbps interface, the SSD is able to deliver exceptional read/write speed, making it the ideal companion for heavy-loading industrial or server operations. ST170-300B (JEDEC MO-300B) utilizes 3D NAND for higher capacity up to 240GB and provides more power efficiency than 2D NAND. It is suitable for Embedded, POS, KIOSK and IPC applications to optimize its operating conditions featuring in high-speed, stability and power savings.

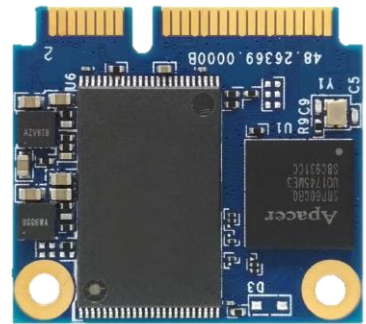

Feature

- Support LDPC ECC
- Global Wear Leveling
- Flash bad-block management
- S.M.A.R.T. and SSD Widget
- Power Failure Management
- End-to-End Data Protection
- TRIM Support
- ATA Secure Erase
- Hyper Cache Technology
- Over-Provisioning

Specifications

Model	ST170-300B
Interface	SATA 3.0 (6Gb/s)
Connector	52-pin mSATA connector
Form Factor	JEDEC MO-300B
NAND Flash Type	3D TLC
Capacity	30GB~240GB
External DRAM	No
Sustained Read Performance (MB/sec)	Up to 560
Sustained Write Performance (MB/sec)	Up to 455
ECC Engine	Low-Density Parity-Check (LDPC) Code
IOPS (4K Random Write)	80K
Standard Operating Temperature (°C)	0 ~ + 70
Storage Temperature (°C)	-40 ~ + 100
H/W Write Protect	No
Thermal Sensor	Yes
Shock	Operation: 50G/11ms (compliant with MIL-STD-202G) Non-operation: 1500G/0.5ms (compliant with MIL-STD-883K)
Vibration	Operation: 7.69 Grms, 20~2000 Hz/random (compliant with MIL-STD-810G) Non-operation: 4.02 Grms, 15 ~ 2000 Hz/sine (compliant with MIL-STD-810G)
Operating Voltage	3.3 V ± 5%
Power Consumption	Active mode: 420 mA / Idle mode: 105 mA
Dimension (L x W x H)	29.85 x 26.80 x 3.85 (mm)
MTBF (hours)	>1,000,000

Mechanical Specification

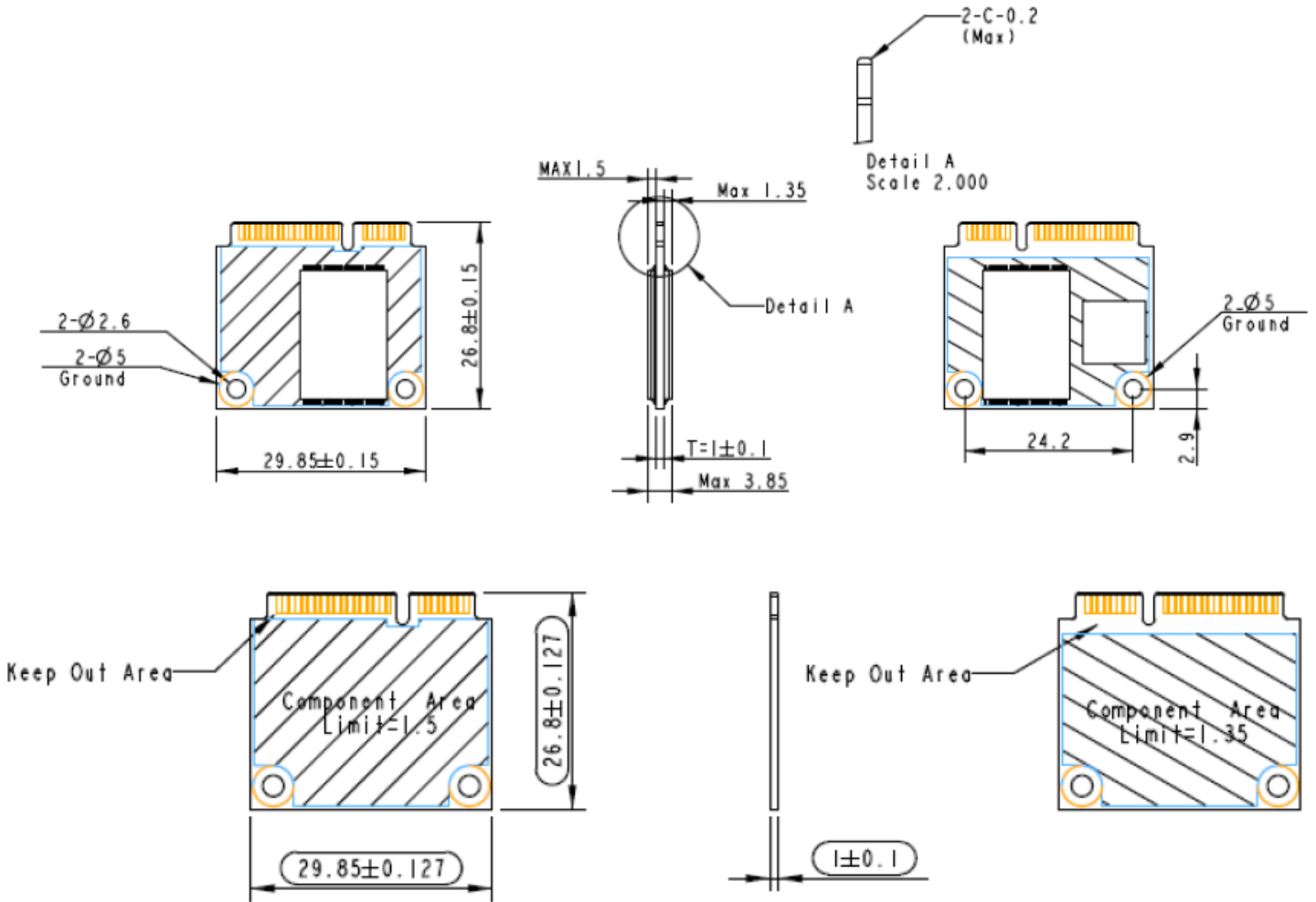

Unit: mm

For more information,
contact your Apacer representative

Global Presence

Taiwan (Headquarters)
Apacer Technology Inc.
Tel: +886-2-2267-8000
Fax: +886-2-2267-2261

Europe
Apacer Technology B.V.
Tel: +31-40-267-0000
Fax: +31-40-290-0686

U.S.A.
Apacer Memory America, Inc.
Tel: +1-408-518-8699
Fax: 1-510-249-9551

China
Apacer Electronic(Shanghai)
Co., Ltd.
Tel: +86-21-6228-9939

Japan
Apacer Technology Corp.
Tel: +81-3-5419-2668
Fax: +81-3-5419-0018

India
Apacer Technologies Pvt. Ltd.
Tel: +91-80-41529061~3
Fax: +91-80-41700215